

CABLE GLAND INSTRUCTIONS

SEAVIEW

For Cable Gland Part Numbers

CG20P-G

CG30P-G

CGM17P-G

CG20A-B

CG30A-B

CGM17A-B

CG20-SS

CG30-SS

CGM17-SS

Refer to website for most up to date instructions and videos.

www.seaviewglobal.com

TOOLS NEEDED

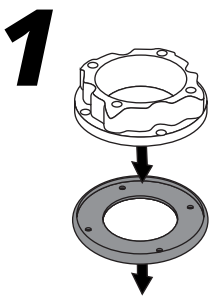
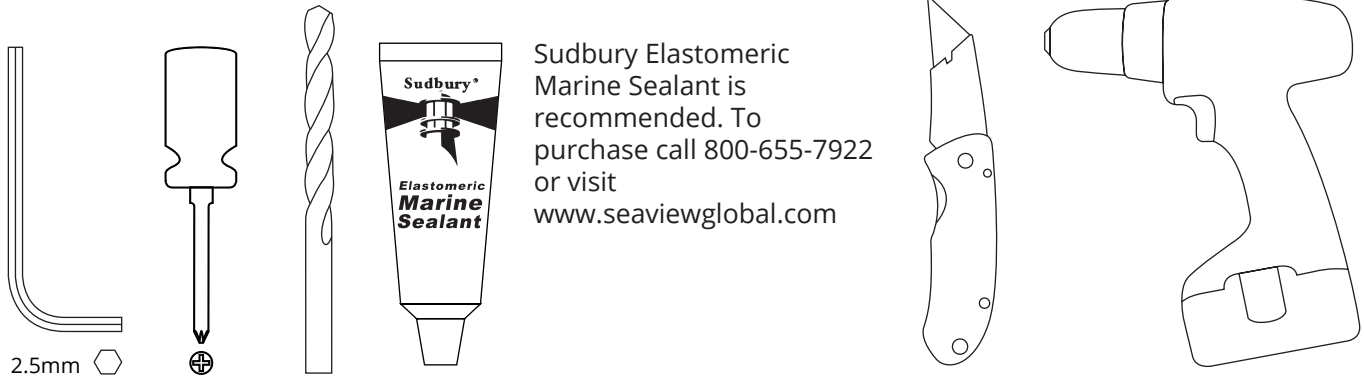

1
Place the plastic base onto the rubber base gasket. Be sure to line up the four screw holes.

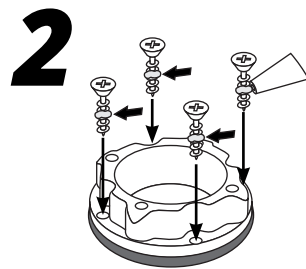

2
Drill pilot holes and secure the base. Apply marine adhesive sealant to the threads of the screws.

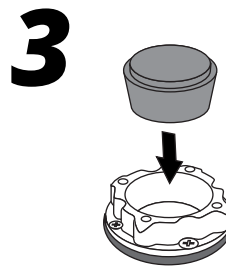

3
Insert the rubber tapered plug into the base.

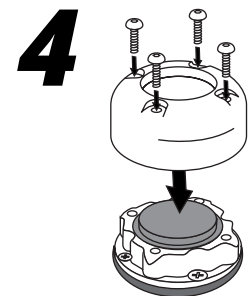

4
Line up the Cable Gland cover with the four holes in the plastic base and screw the bolts in with a 2.5mm wrench, compressing the rubber grommet.

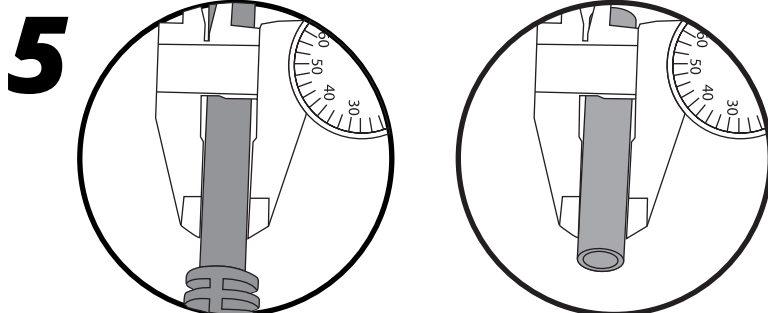

5
Measure your cable diameter and select the appropriate drill tube provided.

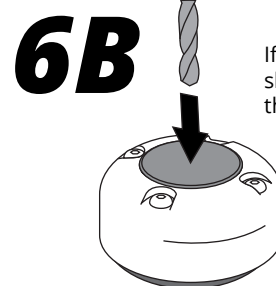

6B
If using the a drill bit, the drill should be run repeatedly through the rubber.

6A 1



Take one of the four drill tubes (included with the Cable Gland). Double check to make sure the tube is the right diameter for your installation.

2

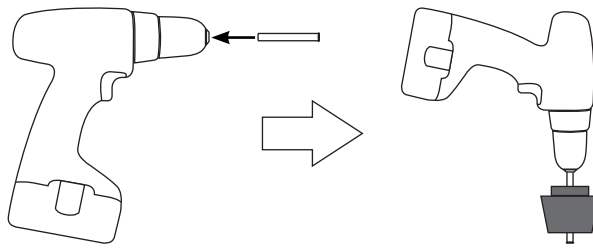

Insert drill tube into drill motor, and leave enough length to get through the tapered plug.

3

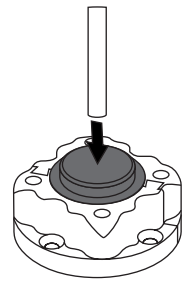

Apply small amount of soapy water to the tube and slowly drill the Cable Gland.

TIP#1

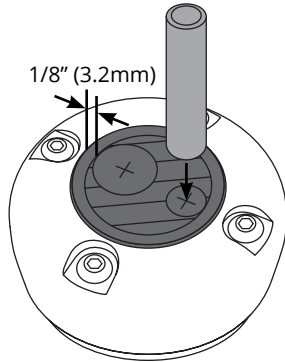

- Make sure that you do not drill within 1/8" (3.2mm) from the edge of the tapered plug.
- A slightly larger drill bit is needed for drilling the rubber.

7

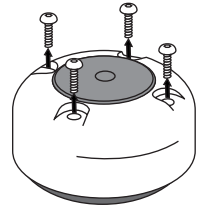

Remove the four screws using a 2.5 mm allen wrench.

8

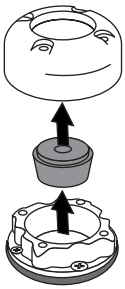

Remove the Cable Gland cover and tapered plug.

9

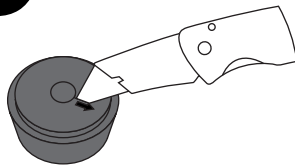

Using a sharp razor blade or knife, cut the tapered plug from the cable hole outward.

10

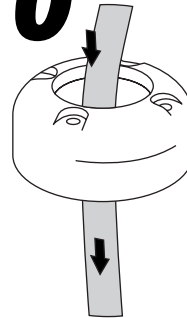

Slide the Cable Gland cover over the electronic cable.

11

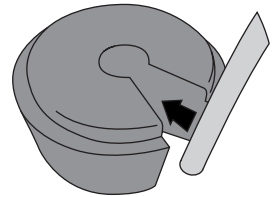

Wrap the tapered plug around the electronic cable.

12

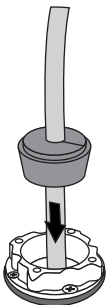

Insert the electronic cable and tapered plug into the plastic base.

13

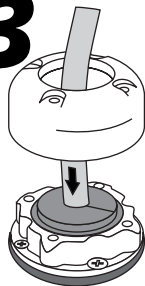

Slide the Cable Gland cover onto the plastic base making sure that all four bolt holes line up.

14

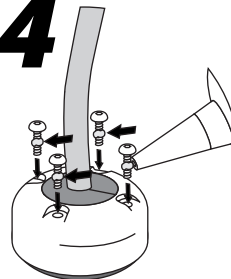

Apply marine adhesive sealant to the four allen head screws and tighten.