

Part Index

*not to scale

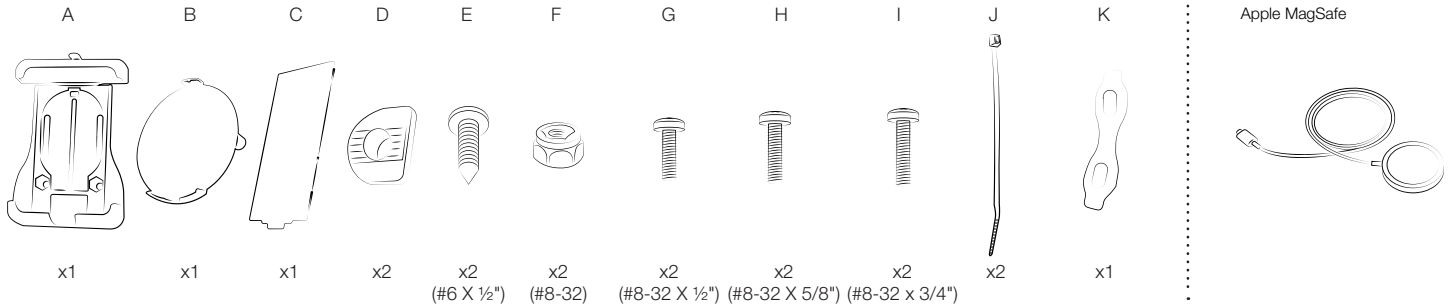

1 Connect (B) Puck Slide to (A) RAM® Quick-Grip™ Holder, using (E) Screws and (D) Ratchet Washers. Do not fully tighten yet.

2 Insert Apple MagSafe into (B) Puck Slide, followed by phone.

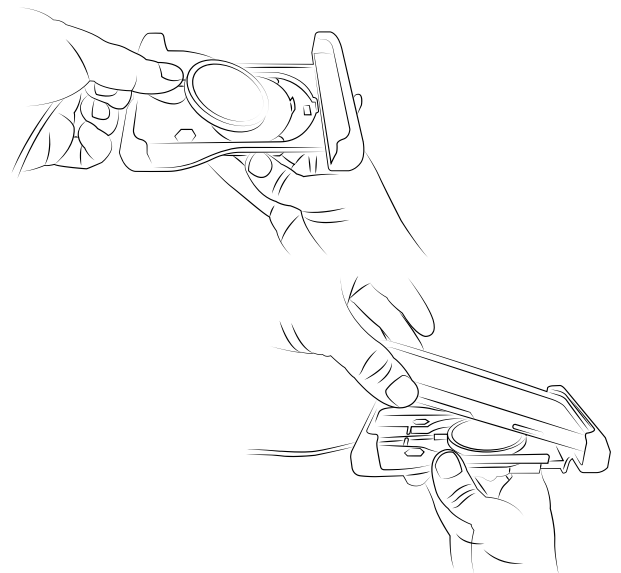
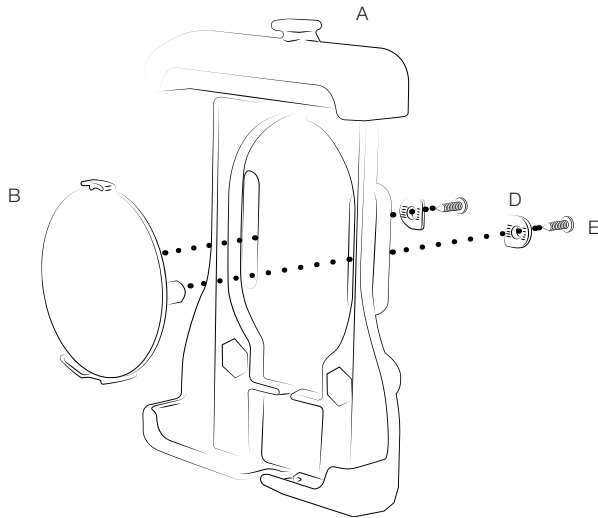

3 Shift Apple MagSafe cable up and down until magnets are properly aligned with phone. Once aligned, fully tighten (E) Screws on the back. Hand-tighten only, do not over-tighten.

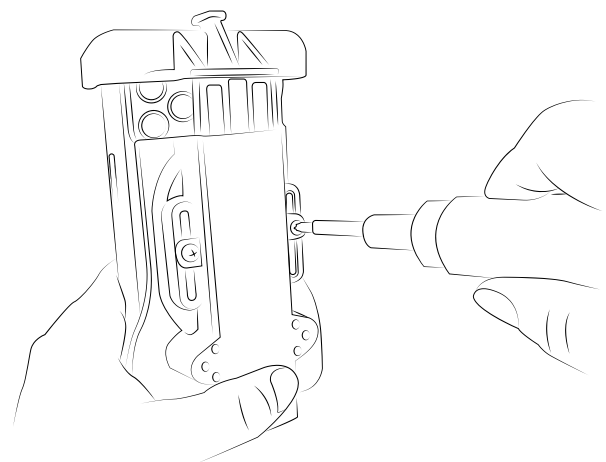
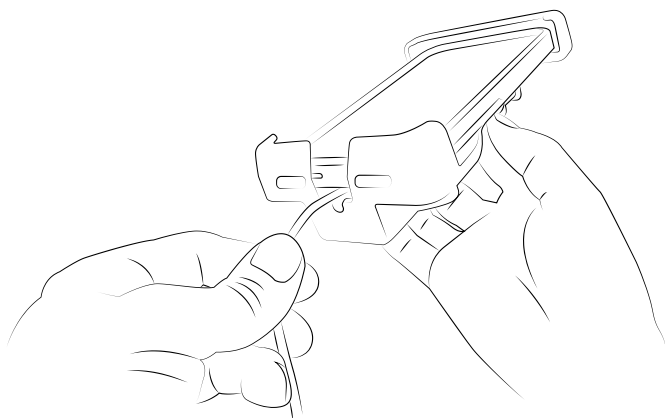

RMR-INS-461



Safety Precaution

Do not install this product near or over an airbag deployment area or in a location that obstructs the driver's vision or interferes with vehicle operation. National Products, Inc does not assume responsibility or liability for any such personal injury, death or property damage.

- 4 Remove phone from holder. Plug Apple MagSafe into power source and connect phone to holder again to ensure proper connection.

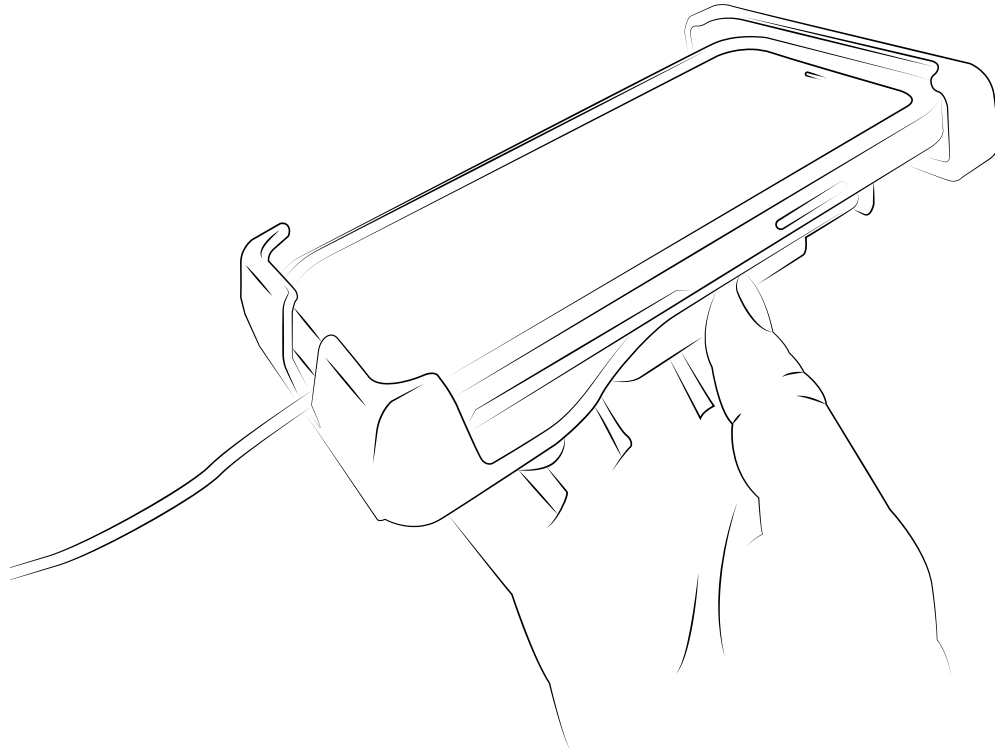

- 5 To connect RAM® Diamond Ball Base (not included), remove device from holder, insert (F) Nuts into nut pockets and connect base with (G, H or I) Screws, and enclose with (C) Panel.

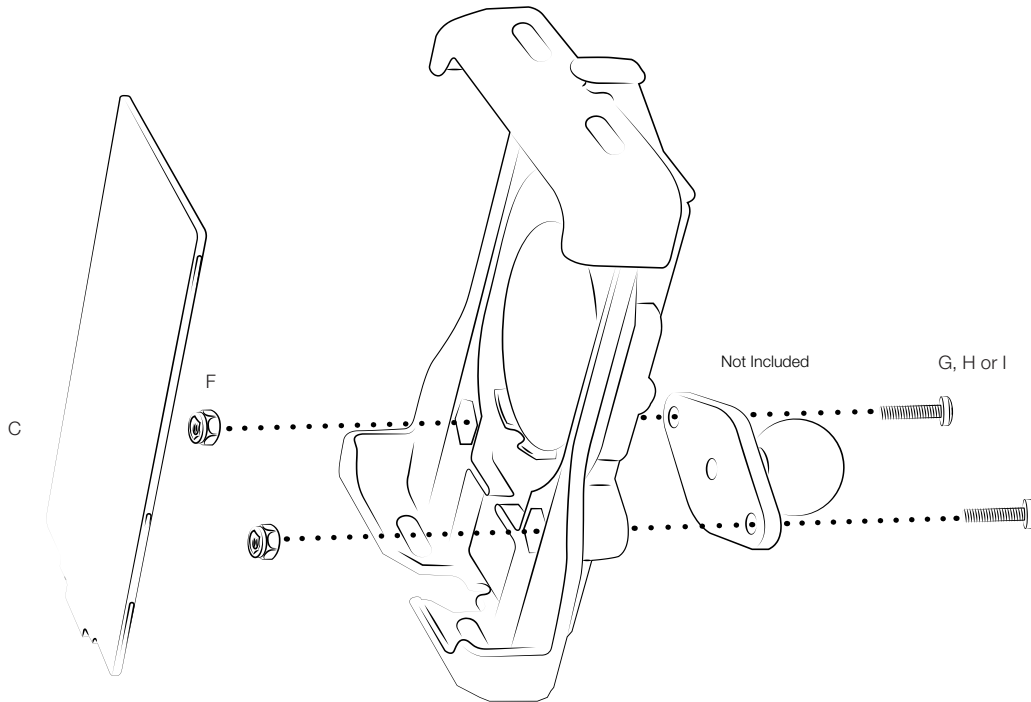

RMR-INS-461



Safety Precaution

Do not install this product near or over an airbag deployment area or in a location that obstructs the driver's vision or interferes with vehicle operation. National Products, Inc does not assume responsibility or liability for any such personal injury, death or property damage.