

# CHIRP

Upgrade Your Sounder to a Serious Fishfinding Machine!  
Only possible with the use of an AIRMAR broadband transducer.

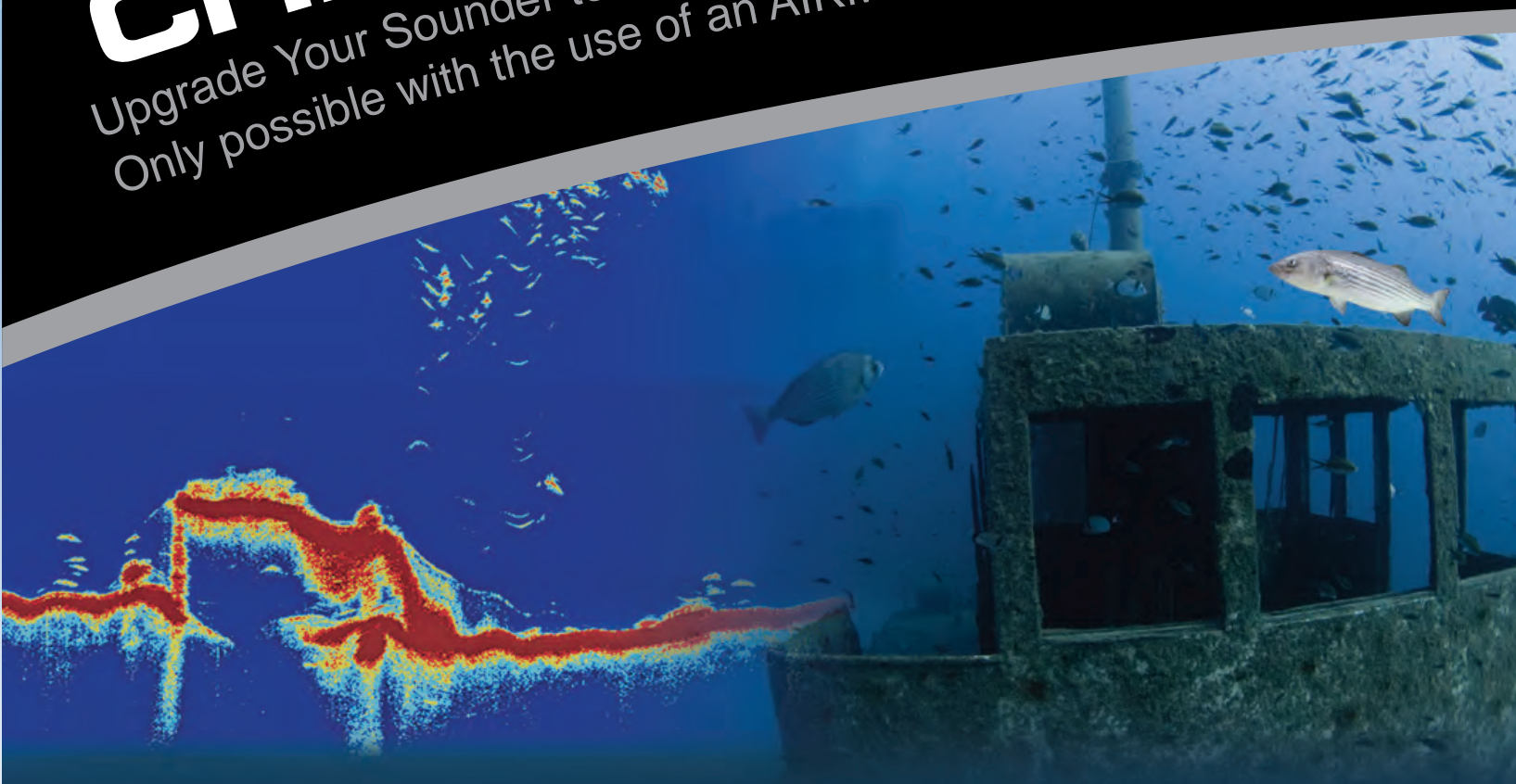

## CHIRP TECHNOLOGY

- 5 to 10 times greater detail and resolution
- 10 to 1,000 times more energy on targets
- Precise separation between baitfish and game fish
- Superior performance in noisy environments
- Improved bottom tracking at high boat speeds

**DEEPER.  
BROADER.  
CLEARER.**

**GAME CHANGING TECHNOLOGY.**



**Small Boat Products**  
**Thru-Hull & Tilted Element™**

Screen shot courtesy of Garmin®.

# Broadband / CHIRP Transducers

## When Your Living Depends on Finding Fish...

Rely on Airmar's new broadband transducers for the ultimate fishing mission. Whether you're a commercial fisherman, charter captain, or tournament angler, there's a new game in town! CHIRP transducers enable bottom detection down to 3,000 m (10,000') with 5 to 10 times greater detail and resolution so precise it's possible to distinguish between individual baitfish, game fish, and underwater structures. One transducer delivers up to 115 kHz of total bandwidth in just one installation, saving customers time and money.

**Airmar...it's what's under your boat.**

## The CHIRP Difference

Traditional marine fishfinders operate at discrete frequencies such as 50 kHz and 200 kHz, use relatively short-duration transmit pulses, and use narrowband sonar transducers. In contrast, CHIRP (compressed high-intensity radar pulse) uses a precise sweep pattern of many frequencies within a long-duration transmit pulse from a broadband transducer, so the equivalent sound energy transmitted into the water is 10 to 1,000 times greater than a conventional marine fishfinder. The echo energy returning to the transducer, superior to that generated by a conventional transducer, is then processed by the fishfinder's DSP (digital signal processing) computer and displayed in ultra-sharp detail on the display. The combination of CHIRP, a broadband transducer, and the fishfinder's DSP, results in dramatically better fish and bottom detection, superior depth capability, and significantly better performance at speed.

## Does YOUR Fishfinder CHIRP?

Only CHIRP/Spread Spectrum sounders using Airmar broadband transducers can operate as a CHIRP fishfinder system. When Airmar's new transducer is paired with a broadband fishfinder, the result is 5 to 10 times greater sensitivity and performance than current fishfinder technology. Packed with exclusive technology like Transducer ID® and newly engineered piezoceramic elements, Airmar transducers are über sensitive and designed to automatically sweep frequency bands from 28 kHz to 210 kHz with no tuning necessary. As a result, all targets detected in the entire bandwidth will be seen on the display rather than only what is identified in traditional frequencies at 50 kHz and 200 kHz.

Airmar's complete line of twenty-four (24) CHIRP transducers are available in seven (7) different mounting options to accommodate almost any hull design. CHIRP transducers are available at Gemeco Marine Accessories [www.gemeco.com](http://www.gemeco.com) and Airmar EMEA [www.airmar.com/emea](http://www.airmar.com/emea). Visit [www.AIRMAR.com](http://www.AIRMAR.com) for a list of CHIRP-ready transducers.

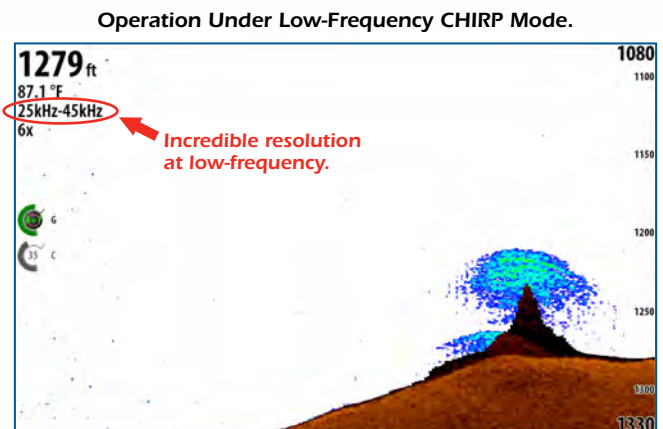
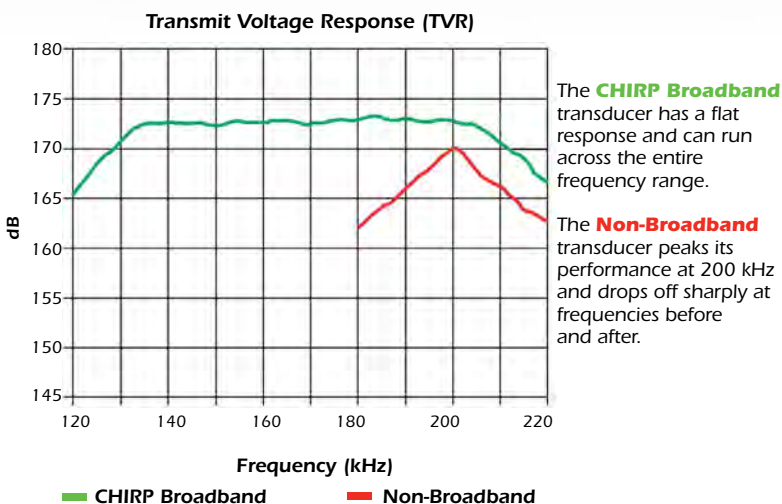

Screen shot courtesy of Simrad®.

# Thru-Hull

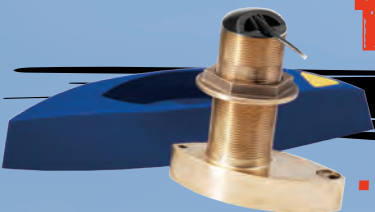

## B765LH (Low & High-Frequency)

MSRP  
\$960.00

- Depth & fast-response water-temperature sensor
- Low—CHIRPS from 40 kHz to 75 kHz, 32° to 21° beamwidth
- High—CHIRPS from 130 kHz to 210 kHz, 15° to 9° beamwidth
- 115 kHz of total bandwidth from one transducer
- Covers popular fishing frequencies of 50 and 200 kHz plus everything else in the bandwidth
- All the advantages of the larger Thru-Hull CHIRP transducers, suitable for smaller boats
- Bronze transducer housing with High-Performance Fairing
- Boat Size: Up to 9 m (30') and above
- Hull Type: Fiberglass or wood

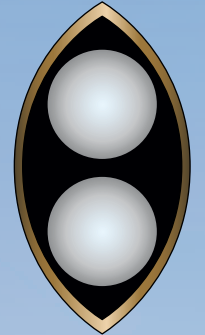

2-Internal  
Broadband Ceramic  
Assemblies



## B765LM (Low & Medium-Frequency)

MSRP  
\$1,080.00

*Medium-frequency benefits include the ability to sound deeper than the high-frequency, along with better target resolution than the low-frequency.*

- Depth & fast-response water-temperature sensor
- Low—CHIRPS from 40 kHz to 75 kHz, 32° to 21° beamwidth
- Medium—CHIRPS from 80 kHz to 130 kHz, 24° to 16° beamwidth
- 85 kHz of total bandwidth from one transducer
- Covers popular fishing frequencies of 50, 88, and 107 kHz plus everything else in the bandwidth
- All the advantages of the larger Thru-Hull CHIRP transducers, suitable for smaller boats
- Bronze transducer housing with High-Performance Fairing
- Boat Size: Up to 9 m (30') and above
- Hull Type: Fiberglass or wood

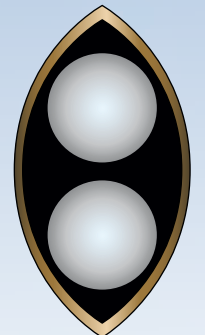

2-Internal  
Broadband Ceramic  
Assemblies

# DIMENSIONS

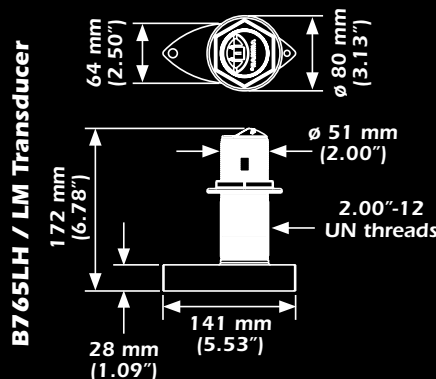
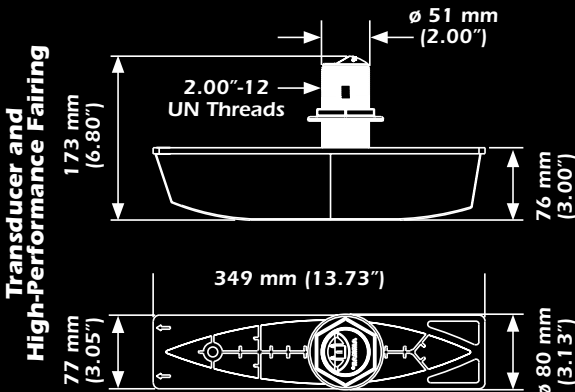

# Tilted Element™

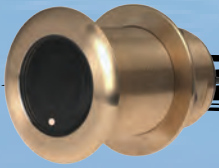

MSRP  
\$750.00

## B75L (Low-Frequency)

- Low—CHIRPS from 40 kHz to 75 kHz, 32° to 21° beamwidth
- Available in 0° or 12° tilted versions only
- 35 kHz of total bandwidth from one transducer
- Covers popular fishing frequency of 50 kHz plus everything else in the bandwidth



1-Internal Broadband Ceramic Assembly

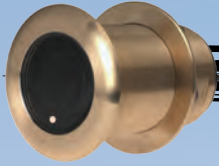

MSRP  
\$855.00

## B75M (Medium-Frequency)

- Medium—CHIRPS from 80 kHz to 130 kHz, 24° to 16° beamwidth
- Available in 0°, 12°, or 20° tilted versions
- 50 kHz of total bandwidth from one transducer
- Covers popular fishing frequencies of 88 and 107 kHz plus everything else in the bandwidth

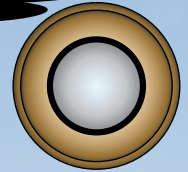

1-Internal Broadband Ceramic Assembly

*Medium-frequency benefits include the ability to sound deeper than the high-frequency, along with better target resolution than the low-frequency.*

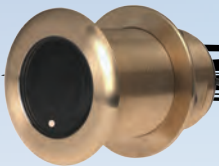

MSRP  
\$740.00

## B75H (High-Frequency)

- High—CHIRPS from 130 kHz to 210 kHz, 15° to 9° beamwidth
- Available in 0°, 12°, or 20° tilted versions
- 80 kHz of total bandwidth from one transducer
- Covers popular fishing frequency of 200 kHz plus everything else in the bandwidth

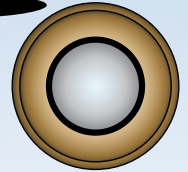

1-Internal Broadband Ceramic Assembly

- Depth & fast-response water-temperature sensor
- Same elements and performance as the B765LH/LM offered in a low-profile housing
- Bronze transducer housing
- Boat Size: Up to 8 m (25')
- Hull Type: Fiberglass or wood

## DIMENSIONS

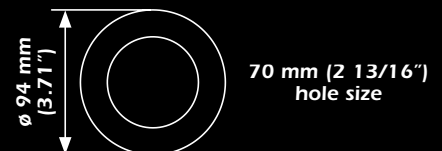
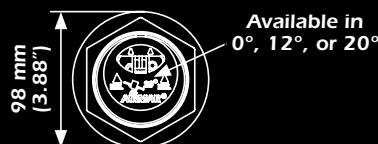
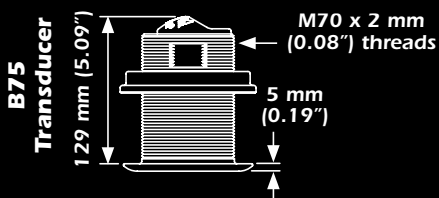

# Tilted Element™

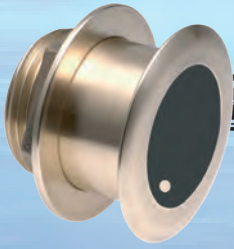

**MSRP**  
\$1,490.00

## B175L (Low-Frequency)

- Low—CHIRPS from 40 kHz to 60 kHz, 32° to 21° beamwidth
- Available in 0°, 12°, or 20° tilted versions
- 20 kHz of total bandwidth from one transducer
- Covers popular fishing frequency of 50 kHz plus everything else in the bandwidth

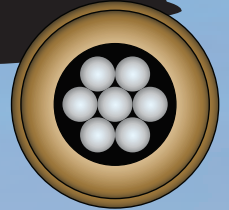

7-Internal Broadband Ceramic Assemblies

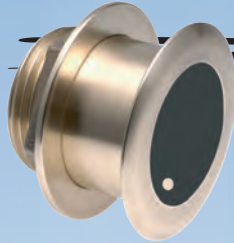

**MSRP**  
\$1,235.00

## B175M (Medium-Frequency)

- Medium—CHIRPS from 85 kHz to 135 kHz, 16° to 11° beamwidth
- Available in 0°, 12°, or 20° tilted versions
- 50 kHz of total bandwidth from one transducer
- Covers popular fishing frequencies of 88 and 107 kHz plus everything else in the bandwidth

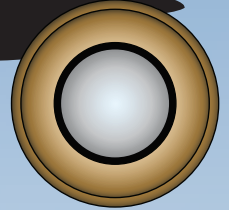

1-Internal Broadband Ceramic Assembly

Medium-frequency benefits include the ability to sound deeper than the high-frequency, along with better target resolution than the low-frequency.

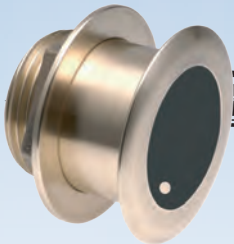

**MSRP**  
\$1,120.00

## B175H (High-Frequency)

- High—CHIRPS from 130 kHz to 210 kHz, 10° to 6° beamwidth
- Available in 0°, 12°, or 20° tilted versions
- 80 kHz of total bandwidth from one transducer
- Covers popular fishing frequency of 200 kHz plus everything else in the bandwidth

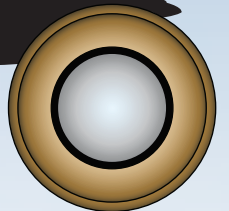

1-Internal Broadband Ceramic Assembly

- Depth & fast-response water-temperature sensor
- Bronze transducer housing
- Boat Size: Up to 11 m (36')
- Hull Type: Fiberglass or wood

## DIMENSIONS

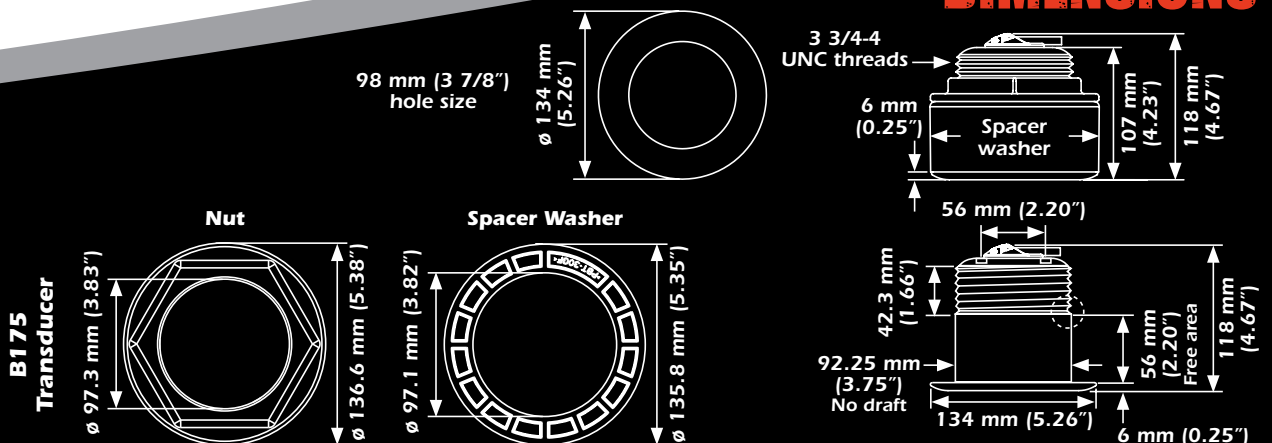

# Technical Information

## Advantages of Thru-Hull Transducers

When thru-hull transducers are installed with a High-Performance Fairing, the transducer face is parallel to the waterline resulting in a beam that is vertically oriented for maximum echo returns and the best possible performance. The fairing compensates for hull deadrise and reduces turbulence over the transducer face, which allows tracking at speeds over 30 knots (35 MPH). This installation, when mounted in clean water (forward of propellers and running gear), produces the most effective signal return since nothing on the vessel interferes with the transducer's active surface. Thru-hull transducers will work with any engine type: inboard, outboard, or I/O.

## Advantages of Tilted Element™ Transducers

Tilted Element transducers are low-profile housings that protrude less than 6.35 mm (0.25") outside of the hull. Rather than using a high-performance fairing block to correct for the hull deadrise, the ceramic element is tilted inside the transducer at either a fixed 12° or 20° angle, accommodating hull deadrise angles up to 24°. When installed to the hull, the tilted feature provides built-in deadrise compensation, aiming the beam vertically which results in strong echo returns and accurate depth readings. Tilted element transducers are an ideal solution for fast, trailered, sportfishing vessels where a thru-hull transducer with a High-Performance Fairing cannot be installed.

## Unique Transducer ID®

Airmar's Transducer ID feature measures and stores the operating parameters for each transducer. This enables the fishfinder to automatically configure itself to the transducer being used. The embedded microcontroller continuously monitors ceramic operating temperatures inside the transducer, enabling closed loop control of power output. The transducer's profile can be presented on the display showing beamwidth coverage as a function of frequency. Stored data also assists with troubleshooting, warranty or any required information about the transducer.

## Quality "Q" Value

Q is a measure of bandwidth and the rise and fall times of target echoes. Airmar Q values range from 1.6 to 30, depending on the model. Competitive transducers have an average Q of 25 to 30. The lower the "Q" number, the less ringing in the transducer and the better the performance—improved individual fish separation along with bottom imaging in rapidly changing water depths such as ledges and offshore canyons. **All Airmar CHIRP transducers have a Q of 3 or less.**

Model	Q / Bandwidth		Roundtrip Sensitivity*	
	LF	HF	LF	HF
<b>B744V (baseline)**</b>	28 / 1.8 kHz	31 / 6.7 kHz	1 times	1 times
<b>B765</b>	2 / 35 kHz	2 / 80 kHz	25 times	20 times
<b>B60 (baseline)**</b>	28 / 1.8 kHz	31 / 6.7 kHz	1 times	1 times
<b>B75</b>	2 / 35 kHz	2 / 80 kHz	25 times	20 times
<b>B175</b>	2.5 / 20 kHz	2 / 80 kHz	280 times	150 times

\*All roundtrip sensitivity data is based on the Figure of Merit (FOM) and the transducer bandwidth relative to the B744V or B60 models.

\*\*Commonly used non-CHIRP transducers.

See *Theory of Operation* for a complete understanding of transducer terminology and operation. [www.airmar.com](http://www.airmar.com)